



# CEN42 (formerly AB-2342)

## Lighted & Unlighted Centennial AK Bollard

### Project Information

Name / Location: \_\_\_\_\_ / \_\_\_\_\_  
 Type / Quantity: \_\_\_\_\_ / \_\_\_\_\_  
 Sold to: \_\_\_\_\_  
 PO#: \_\_\_\_\_

### Approvals

\_\_\_\_\_  
 \_\_\_\_\_  
 \_\_\_\_\_

### Perspective

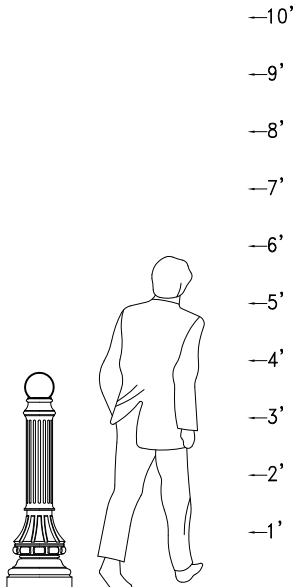

### Bollard Detail

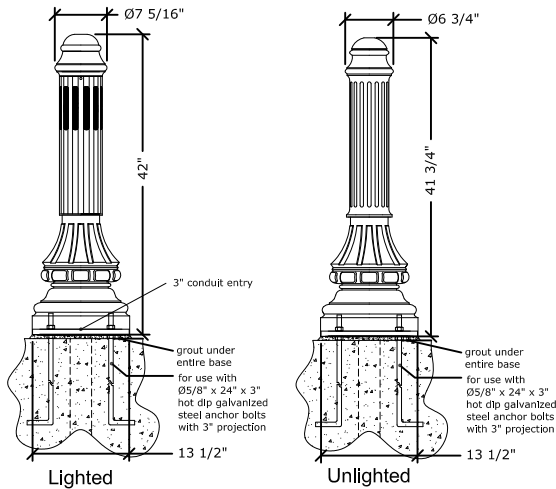

### Specifications

**Construction:**  
 All cast aluminum parts shall be low copper alloy A356. All extruded aluminum parts shall be alloy 6061-T6, 6063-T5 or equal.

**Electrical Assembly:**  
 The electrical assembly shall be comprised of a high power factor ballast, designed to operate an HID lamp (by others) up to 70 watts and shall be integrally mounted to a removable aluminum tray with nonferrous brackets and fasteners. The lampholder shall be porcelain glazed and rated for 600V and 4KV pulse for medium based lamps. Electronic ballasts shall be supplied for all CFL sources and are an option for HID sources; consult factory for details.

The bollard shall be NRTL listed and suitable for wet locations.

**Anchor Bolts:**  
 5/8"X12"X3" anchor bolts, double hex nuts and flat washers shall be hot dipped galvanized steel. A bolt circle template shall be provided.

**Fasteners:**  
 All fasteners shall be stainless steel. When tamper resistant fasteners are required, spanner HD (snake eye) style shall be provided (special tool required, available at additional cost).

**Finish:**  
 Finish shall be Beacote III polyester powdercoat electrostatically applied and thermocured. Bollards shall be subjected to iron-phosphate chemical pre-treatment prior to painting by immersion process.

### Anchor Bolt Pattern

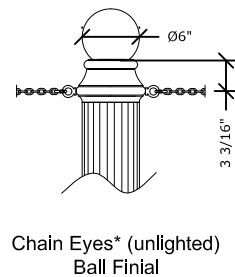
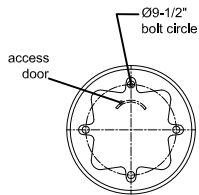

### Style Options

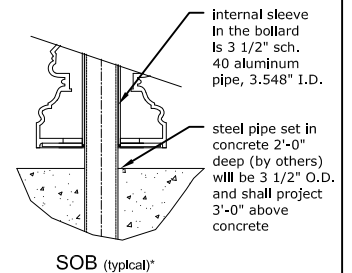
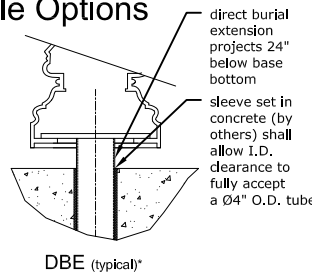
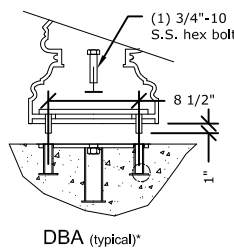

### Ordering Example:

CEN42L / AC / MH70-120-D / BL / PEC / BB

## CEN42

<b>Style</b> <input type="checkbox"/> L Lighted <input type="checkbox"/> U Unlighted	<b>Source</b> MH50 50w metal halide MH70 70w metal halide HPS50 50w high pressure sodium HPS70 70w high pressure sodium CF42 42w compact fluorescent INC incandescent (150w max) OTHER	<b>Socket</b> <input type="checkbox"/> D medium <input type="checkbox"/> G12 G12 bi-pin* <input type="checkbox"/> 4P 4-pin (compact fluorescent)	<b>Electrical Options</b> <input type="checkbox"/> PEC photocell* <input type="checkbox"/> FS fuse holder <input type="checkbox"/> EB electronic ballast <input type="checkbox"/> IQ IQ On Board	<b>Finish</b> <input type="checkbox"/> BB black <input type="checkbox"/> BZ bronze <input type="checkbox"/> BG green <input type="checkbox"/> BW white <input type="checkbox"/> BY gray <input type="checkbox"/> RAL RAL- <input type="checkbox"/> OTHER <small>Consult factory for premium and verde finishes. Custom colors available.</small>
<b>Lens Material</b> <input type="checkbox"/> A Acrylic <input type="checkbox"/> P Polycarbonate	<b>Optical Options, Distribution</b> <input type="checkbox"/> BL bare lamp, type V	<b>Style Options</b> <input type="checkbox"/> BAL 6" Ball Finial <input type="checkbox"/> CES chain eye, single** <input type="checkbox"/> CED chain eye, double** <input type="checkbox"/> DBA direct burial adaptor* <input type="checkbox"/> DBE direct burial extension* <input type="checkbox"/> SOB slip over bollard***		
<b>Lens Finish</b> <input type="checkbox"/> C Clear <input type="checkbox"/> F Frosted <input type="checkbox"/> W White	<b>Voltage</b> <input type="checkbox"/> 120 120v <input type="checkbox"/> 208 208v <input type="checkbox"/> 240 240v <input type="checkbox"/> 277 277v <input type="checkbox"/> 347 347v* <input type="checkbox"/> 480 480v*	<b>Notes:</b> * Consult Factory ** Specify Location, Unlighted Only *** Unlighted only, 3.5" internal clearance		