

arm details

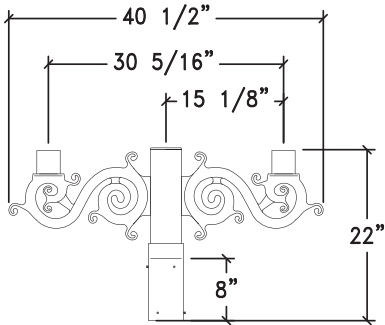

wall bracket details

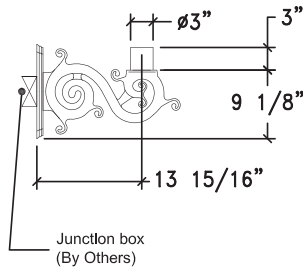

wall plate details

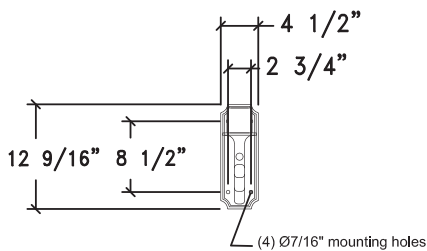

ordering logic

model

- AA-98 Barolo

post shaft profile

- W wall mount
 S smooth
 F fluted

post shaft diameter

- W wall mount
 4 4"
 5 5"
 6 6"
 OTHER _____

arrangement

_____ see arrangement table below

luminaire mounting

- T tenon 
 P pendant 

color

- BB black
 BZ bronze
 GR green
 WH white
 BY gray
 RAL RAL _____

ordering example

AA-98 / S / 4 / B / P / BB

specifications

construction

All cast aluminum parts shall be low copper alloy A356. All extruded aluminum parts shall be alloy 6061-T6.

crossarm installation

The crossarm is designed to slip over an 8"H section of the pole top and is secured with six stainless steel set screws. Standard mounting adaptor (as illustrated) has been designed for 1.5G vibration conditions, when used with a Beacon Products luminaire. Please consult factory for special mounting provisions or installation conditions (e.g. bridges).

wall bracket installation

The wall bracket is anchored to the wall by four mounting bolts, which are not provided by Beacon, as their size (maximum diameter 3/8"), type of fastener and length will vary according to the wall or mounting surface. The recommended maximum external projection of the mounting bolts is 1.25". The junction box is not provided by Beacon, however the bracket is designed to conceal a fully recessed rectangular single-gang junction box. Please consult factory for special mounting provisions or installation conditions.

EPA (effective projected area)











EPA is defined as (surface Area X drag Factor) and measured in ft². Allowable post, luminaire arm, luminaire and accessory EPAs are derived from the most current published AASHTO (American Association of State Highway and Transportation Officials) standard, currently AASHTO 2001 (50yr design life). Customer assumes all responsibility for selecting the appropriate post for installation (consult factory for assistance). Luminaire arm, luminaire and accessory EPA must be equal to or less than allowable EPA of post. Consult a professional engineer for compliance with local codes and standards.

fasteners

All fasteners shall be stainless steel. When tamper resistant fasteners are required, spanner HD (snake eye) style shall be provided (special tool required).

finish

Finish shall be Beacote V polyester powdercoat paint, electrostatically applied and thermocured. All painted surfaces shall be subjected to chemical pre-treatment prior to painting by full immersion process. Finish shall meet or exceed AAMA 2604 standards.

		arrangement (EPA index ft ² / weight (lbs))									
											
shaft		A	B	C	D	E	F	G	H	I	J
wall	weight	10	-	-	-	-	-	-	-	-	-
4"	EPA	-	1.01	1.01	1.01	.81	.81	.81	1.01	-	-
	weight	-	14	22	22	22	31	31	31	-	-
5"	EPA	-	1.12	1.12	1.12	.90	.90	.90	1.1	-	-
	weight	-	16	24	24	24	33	33	33	-	-
6"	EPA	-	1.23	1.23	1.23	.98	.98	.98	1.23	-	-
	weight	-	21	29	29	29	38	38	38	-	-